

TAMAÑO COMPACTO INTEGRADO A LA ARQUITECTURA. CONFORT VISUAL EFICIENTE EN EL PLANO CENITAL.

UGR < 10

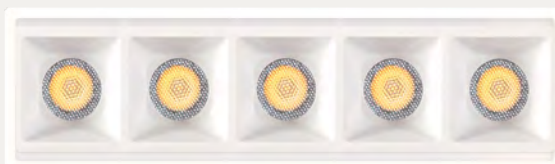

PREMARCO



UGR < 19



AÑOS DE GARANTÍA



# RUNNER X PRO 10W

Artefacto de iluminación para embutir. Driver dimerizable incluido.  
Cuerpo de aluminio y reflector de policarbonato.

💡 1150 lm

⚡ 10W 220V

⚙️ CRI 90

📉 PF 0.93

🌒 Dim

📐 15° / 30° / 45°

🌡️ 2700K / 3000K

UGR < 10

**SAMSUNG** LED

# RUNNER X PRO 10W

## ESPECIFICACIONES TÉCNICAS

Código	CT	Dim.	Sist. dim	Áng.	CRI	lm	lm/W	W	V	Led	UGR	IP
MXB5	2700K	Sí	TRIAC	15°/30°/45°	90	1150	115	10	220	Samsung	<16	20
MXB5	3000K	Sí	TRIAC	15°/30°/45°	90	1150	115	10	220	Samsung	<16	20

MacAdam 3

## DISTRIBUCIÓN DE INTESIDAD LUMÍNICA

15° UGR<10

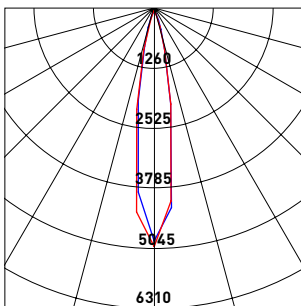

30° UGR<10

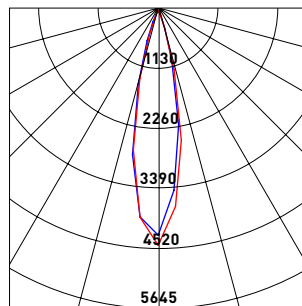

45° UGR<10

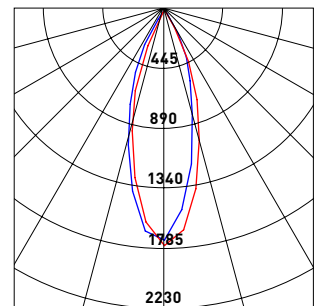

15° UGR<19

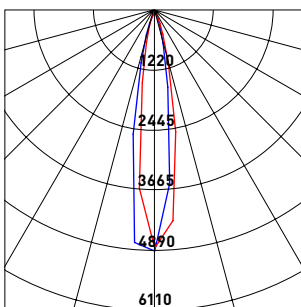

30° UGR<19

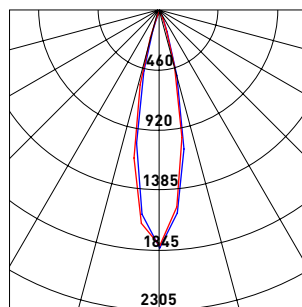

45° UGR<19

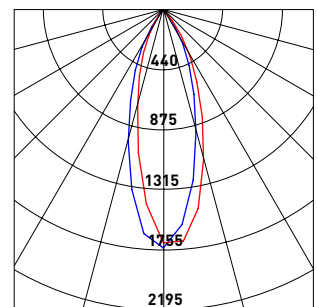

# RUNNER X PRO 10W

## PROYECCIÓN DE LUZ A DISTANCIA

15° UGR<10

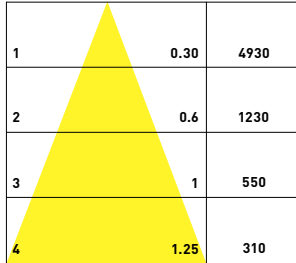

M (Altura) M (Diámetro) lx

30° UGR<10

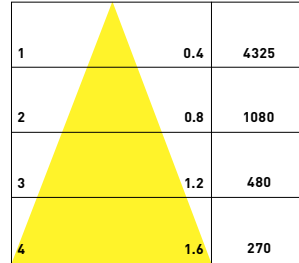

M (Altura) M (Diámetro) lx

45° UGR<10

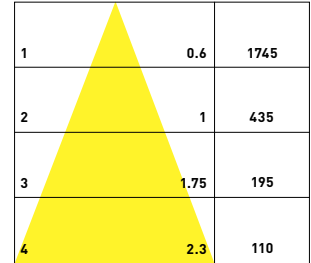

M (Altura) M (Diámetro) lx

15° UGR<19

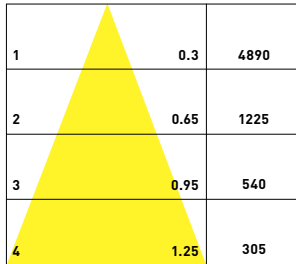

M (Altura) M (Diámetro) lx

30° UGR<19

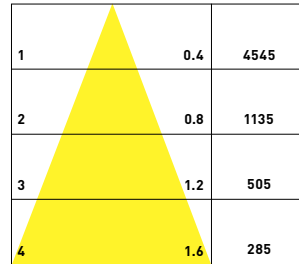

M (Altura) M (Diámetro) lx

45° UGR<19

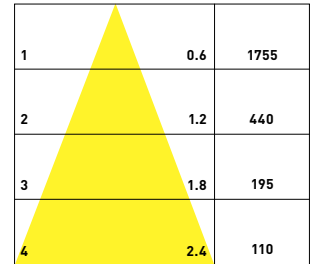

M (Altura) M (Diámetro) lx

## DIMENSIONES DRIVER TRIAC (mm)

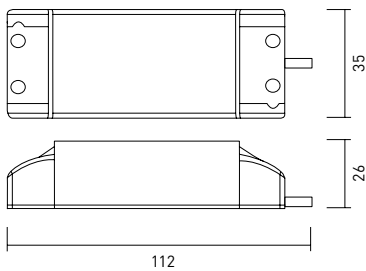

## DIMENSIONES RUNNER X PRO (mm)

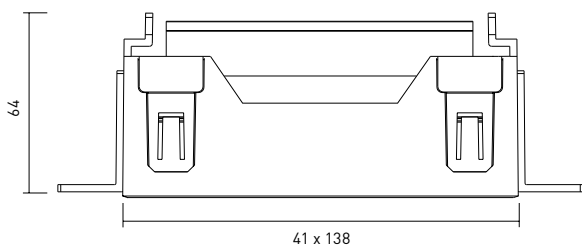

42 x 143

